

DS-1272ZJ-120

120 Wall Mounting Bracket for Mini Dome Camera

Features:

- Aluminum alloy material with surface spray treatment
- Waterproof rubber suits for indoor/outdoor design
- The outlet hole makes the feature looks better
- Better water proof as nose-up pitch design
- Matched junction box has the waterproof stopper

Dimension:

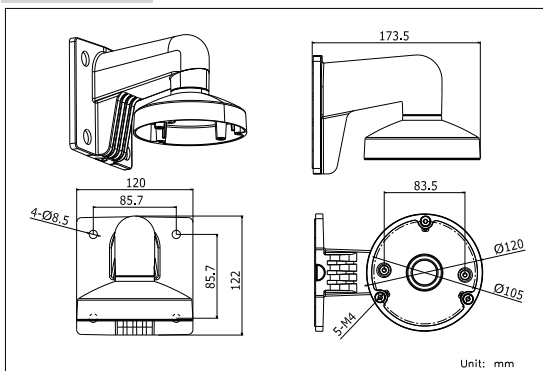

Order Model:

DS-1272ZJ-120

Parameter:

Model	DS-1272ZJ-120
Parameters	120 Wall Mounting Bracket for Mini Dome Camera
Appearance	Hik White
Range of Application	Suitable for dome camera wall mounting
Material	Aluminum Alloy
Dimension	120×122×173.5mm
Weight	440g

Notice:

- The bracket should be installed on flat wall
- Waterproof rubber is necessary for outdoor application
- The wall must be capable of supporting over 3 times as much as the total weight of the camera and the mount.
- The maximum load capacity of the bracket is 4.5KG

Model Suitable:

DS-2CS58A1P-IRS, DS-2CS54A1P-IR, DS-2CD2512F-I(W), DS-2CD2532F-I(W), DS-2CD7133-E, DS-2CD7153-E, DS-2CD7164-E

Installation Step:

① Choose the appropriate wall and thread the wire

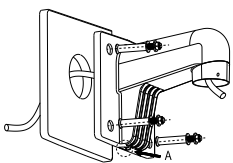

A: Reserved hole for wiring

② Fix the adapter to bracket and thread the wire

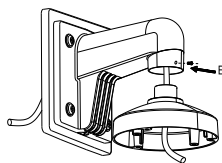

B: Tightening Screw

③ Screw up and fix the adapter

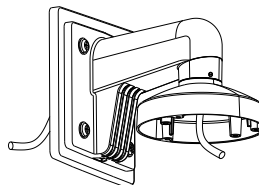

④ Get off the transparent cover and check the hole site of adapter plate

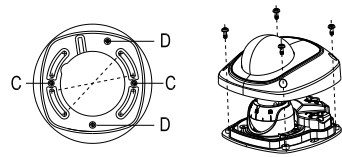

C: DS-2CS58A1XX, DS-2CD25XX
D: DS-2CD71XX

⑤ Install the adapter to the bracket and screw up

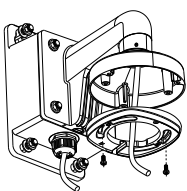

⑥ Connect the camera wire and fix the camera onto the adapter plate

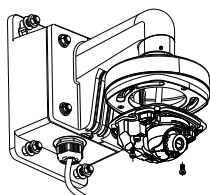

⑦ Modify the angle of monitoring, install the transparent cover and screw up

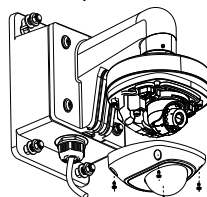

⑧ Bracket Installation complete.

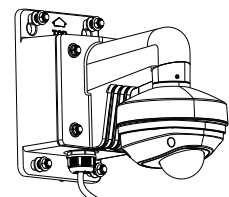

Note: The actual bracket may vary from the picture above.